



CATALOGO IDM

IMPIANTI A FUNE - SCIOVIE - BATTIPISTA - INNEVAMENTO - PAVIMENTI



Il più grande
catalogo multimarca

L'esperto tecnico
francese dal 1993

Impegnati in una
montagna ecologica



SIAMO CON VOI DAL 1993 IN DIRETTA DALLA SAVOIA!



IL TEAM DI VENDITA

Francia (Alpes du Sud | Bauges | Chablais | Corse | Giffre | Isère | Jura | Massif Central | Pyrénées | Vosges) - **Andorra - Spagna**



Bastien LAURENT | Commerciale
+33 7 60 16 24 28
bastien.laurent@idm-france.com



Jean-Pierre BLANCHARD | Ass. vendite
+33 4 79 84 34 37 | +33 6 02 54 11 21
jp.blanchard@idm-france.com

Francia (Aravis | Beaufortain | Haute Tarentaise | Maurienne | Mont-Blanc | Tarentaise | Val d'Arly | Chamonix) - **Svizzera francese**



Damien LAYMOND | Commerciale
+33 6 09 59 23 93
damien.laymond@idm-france.com



Fanny MESSINA | Ass. vendite
+33 4 79 84 00 53 | +33 6 56 68 73 98
fanny.messina@idm-france.com

Italia - Ticino - Export Mondo (esclusi i settori già citati)



Julien GUILLOTEAU | Commerciale
+33 6 87 14 55 57
julien.guilloteau@idm-france.com

Austria - Germania - Svizzera orientale



Florent DEBONNET | Commerciale
+43 676 6518309
florent.debonnet@idm-austria.com

SHOP IDM



CONTATTACI !

+ 33 4 79 84 34 34

Da lunedì a venerdì, dalle 08:00 alle 12:15 e dalle 13:30 alle 17:30

shop.idm-france.com

Oltre 2.000 riferimenti IDM disponibili online 24 ore su 24, 7 giorni su 7

Seguici sui social network



@IDMFrance

IL RIFLESSO **ecovertis**[®] SIGNIFICA RISPARMIARE CO2!



Affidandoci la **raccolta e il riciclaggio** dei vostri ricambi usati, possiamo quantificare il vostro risparmio di CO2.



Il piacere di **consumare in modo diverso**. Risparmiate CO2 con la nostra gamma di prodotti eco-responsabili Ecovertis!



235 000

KG di CO2 risparmiati da
IDM e dai suoi clienti
partner di Ecovertis[®]

ecovertis

STANNO MIGLIORANDO LA LORO IMPRONTA DI CO2 CON ECOVERTIS[®]



LA PLAGNE



COURCHEVEL



MÉRIBEL



LES ARCS

-8406 kg



Val d'Isère



Val Thorens



Serre Chevalier Vallée



-3876 kg



SAINT GÉRALD



métabief



-750 kg



les 2 alpes



la Rosière



TIGNES



aramon



-2730 kg



CHAMROUSSE



AVORIAZ



La Clusaz



LE GRAND BORNAND



CHAMONI MONT-BLANC



-6750 kg



SCOTAMINES



friendly Menuires

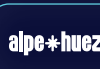

alpe+huez



-7263 kg



megève



LE BÉNÉDICTIN

ANCHE NOI SIAMO COINVOLTI!



Certificata *Société à mission*

Status giuridico francese riservato alle imprese con obiettivi ambientali



134 dividendi climatici distribuiti 2024

Aiutiamo i nostri clienti a risparmiare CO2



134.000 kg di CO2 risparmiati 2024

Sostenere l'economia circolare e il riciclaggio della gomma





ANELLI IN GOMMA

Il più grande catalogo di anelli in gomma e fodere pulegge per impianti di risalita. Gli anelli in gomma IDM / SEMPERIT garantiscono le prestazioni e la durata dei vostri impianti da oltre 30 anni. Il nostro vasto catalogo vi permette di trovare l'anello in gomma perfettamente adatto alle vostre esigenze, garantendo così affidabilità e durata dei vostri impianti.



COMPATIBILITÀ AL 100% GARANTITA



+ 600.000 ANELLI IN GOMMA VENDUTI



AMMISSIBILI AL RICICLAGGIO ECOVERTIS

**IDM**

L'INDESCRIVIBILE

GOMMA AD ALTA DENSITÀ

GARANTITO PER 30.000 KM

PIÙ DI 400 REFERENZE

Dal 1993, l'anello standard in gomma IDM offre prestazioni, robustezza e durata !

**SRI**

IL VIRTUOSO

I VANTAGGI DELL'ANELLO **IDM**

+

50% DI MATERIALE RICICLATO E BIOBASED

Robusto, affidabile e più ecologico, l'anello SRI ti darà soddisfazione e ridurrà le emissioni di CO2



ID SOFT

LONG LIFE

L'INCOMPARABILE

FINO AL **-18%** DI RIDUZIONE DEL DISTURBO ACUSTICO E DELLE VIBRAZIONI

+

LA GARANZIA DI 30 000 KM



ALTRI ANELLI IN GOMMA DISPONIBILI

**High Load ++**

Gomma ultra resistente

**Presa di moto**

Utilizzo specifico in stazione

**Isolante**

Gomma con isolamento elettrico

**HDPE**

La robustezza e la longevità

I NOSTRI ANELLI E FODERE PER PULEGGE SONO COMPATIBILI CON I MARCHI

Agudio Poma® - Bartholet® - Bühler® - CCM® - DCSA® - De Pretis® - Doppelmayr® - Garaventa® - Girak® - Giovanola® - GMM® - Leitner® - LP® - LST® - MEB® - Montaz® - Poma® - Skirail® - Von Roll® - Waagner Biro® - Yan®



FODERE PER PULEGGE



COMPATIBILITÀ AL 100% GARANTITA



AMMISSIBILI AL RICICLAGGIO ECOVERTIS

Sviluppata da **SEMPERIT**
Since 1906GARANZIA
30 000 KMLA FODERA  **IDM**

La fodera pulegge IDM è sinonimo di affidabilità da oltre 30 anni. Scopri la nostra vasta scelta per ottimizzare i tuoi impianti.

PIÙ DI 80 VARIANTI STANDARD O ISOLANTE

SU MISURA POSSIBILE

GOMMA SBR

Scopri anche i nostri **tacchetti per trasporto a fune!**

RICAMBI PER TRASPORTI A FUNE



MARCATORI AVIFAUNISTICI

Marcatore anticollisione per uccelli efficace e autonomo
Ganascia potente, struttura rinforzata e facile da installare sul fune multipolare► **MODELLO PRESENTATO** 07920 MARCATORE ULTRA ALPSBUONA AZIONE
PER LA FAUNA

AMMISSIBILI AL RICICLAGGIO ECOVERTIS

PNEUMATICI E CAMERE D'ARIA

Un'ampia gamma di pneumatici con o senza camera d'aria
Design e strutture rinforzate progettate per un uso intensivo► **MODELLO PRESENTATO** 07517 PNEUMATICO TIPO LP

MARCA CONSIGLIATA DAI GRANDI COSTRUTTORI

LUBRIFICANTI E GRASSI

KLÜBER
LUBRICATIONESCLUSIVA FRANCIA 

Formulati per offrire una lubrificazione di precisione in condizioni di freddo

ALTRI RICAMBI DISPONIBILI



Cinghie

Standard e speciali cinghie



Cuscinetti a sfera

La gamma completa NTN-SNR



Tubi poggiapiedi

40 varianti (unità o rotolo)



Ricambi specifici

Da scoprire sullo Shop IDM



SELLERIA

Dai nostri laboratori in Savoia, realizziamo a mano i vostri sedili e schienali per seggiovie e i vostri sellini per motoslitte. Ascoltando le vostre esigenze e i vostri vincoli, progettiamo pezzi durevoli e perfettamente adatti ai vostri impianti ! Un team reattivo e appassionato vi aspetta!



COMPATIBILITÀ GARANTITA AL 100%



FABBRICAZIONE IN SAVOIA - FRANCIA



PIÙ DI 500.000 PEZZI REALIZZATI



I PEZZI DELLA NOSTRA SELLERIA

SELLE MOTOSLITTE

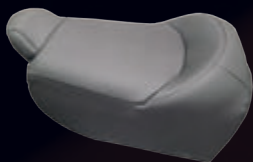

CUSCINI



SCHIUMA E TELA RICICLATE

SCHIENALI



SCHIUMA E TELA RICICLATE

LA NOSTRA SELLERIA È COMPATIBILE CON I MARCHI

Agudio Poma® - Bartholet® - Bühler® - CCM® - DCSA® - De Pretis® - Doppelmayr® - Garaventa® - Girak® - Giovanola® - GMM® - Leitner® - LP® - LST® - MEB® - Montaz® - Poma® - Skirail® - Von Roll® - Waagner Biro® - Yan®



FUNE PER TRASPORTO A FUNE E SERVIZI

Le funi IDM / Teufelberger-Redaelli per il trasporto a fune sono innovazioni all'avanguardia e prodotti di alta gamma. Realizzeremo la fune su misura in base alle vostre esigenze e metteremo a frutto tutta la nostra comprovata esperienza nel campo delle funi in acciaio ad alte prestazioni.

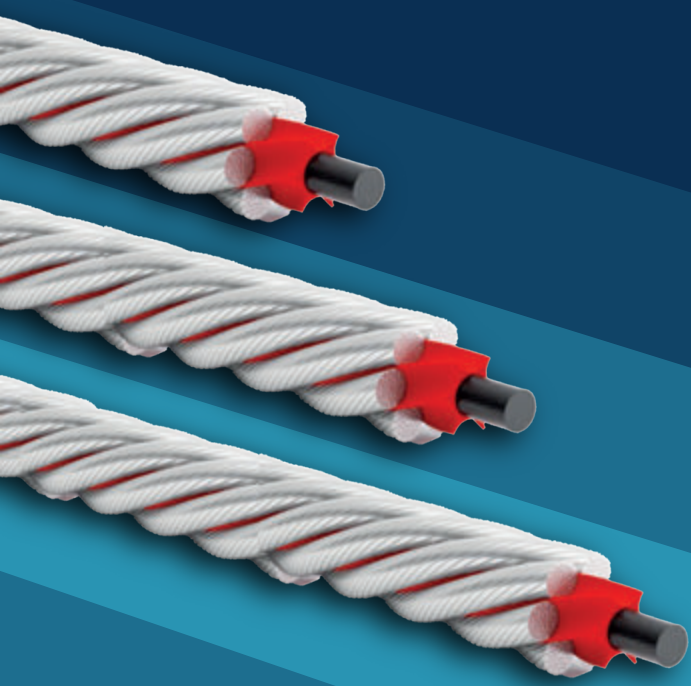

BEST-SELLER

REDMONT® DUAL CORE



- ▶ TECNOLOGIA DUAL CORE
- ▶ COMPORTAMENTO DI ALLUNGAMENTO RIDOTTO
- ▶ DESIGN IN ACCIAIO A LUNGA DURATA

NUOVO

SOLITEC® XD



- ▶ PROGETTATO PER OPERAZIONI INTENSIVE
- ▶ RIDUZIONE DEL 40-60% DI VIBRAZIONI E RUMORE
- ▶ OTTIMIZZATO PER LE GRANDI DIMENSIONI

TELECABINA 2S/3S



FUNIVIA A VA E Vieni



FUNIFOR



FUNITEL / DMC

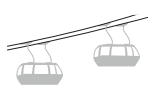

CABINOVIA

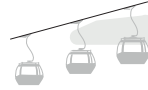

SEGGIOVIA



+ INSTALLAZIONE COMPLETA CON IL NOSTRO PARTNER  CÂBLES & MONTAGE

 UN VEICOLO È TUTTO QUELLO CHE SERVE! | - 45% DE CO2 EQ





FODERE PER PULEGGE



COMPATIBILITÀ GARANTITA AL 100%



AMMISSIBILI AL RICICLAGGIO ECOVERTIS



FODERA

**IDM**

Sviluppato da **SEMPERIT** 
Since 1906.



LA FODERA IN GOMMA ROTOLO E LUNGHEZZA

GOMMA SBR PER PULEGGIA DI SKI LIFT

GARANZIA 30 000 KM

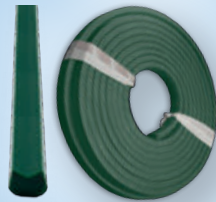

LA FODERA IN POLIURETANO ROTOLO E LUNGHEZZA

POLIURETANO ULTRA RESISTENTE PER PULEGGIA DI SKI LIFT

MASSIMA RESISTENZA

LE NOSTRE FODERE SONO COMPATIBILE CON I MARCHI

Doppelmayr® - Leitner® - Montagner® - Montaz® - Pingon® - Poma®



FUNE PER SKILIFT E SERVIZI

Teufelberger - Redae
Together in Motion

REDMONT® DUALCORE PER SKI LIFT



- ▶ ANIMA SINTETICA (DUALCORE)
- ▶ COMPORTAMENTO AL ALLUNGAMENTO RIDOTTO
- ▶ DESIGN ACCIAIO A LUNGA DURATA



Scegli il tipo

da 10 a 26 mm



REDMONT® DUALCORE
FUNE CLASSICA

+ **rotondo**

Più silenzioso
Meno vibrazioni
Meno usura



REDMONT® DUALCORE
FUNE FORMING



La qualità della fune



PROTEZIONE E FINITURA
CHIARA

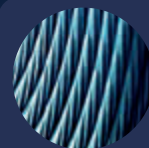

PROTEZIONE E FINITURA
ZINCATA



INSTALLAZIONE COMPLETA CON IL NOSTRO PARTNER



CÂBLES & MONTAGE



PEZZI DI RICAMBIO PER SCIOVIE

SKILIFT SGANCIABILE

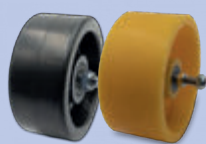
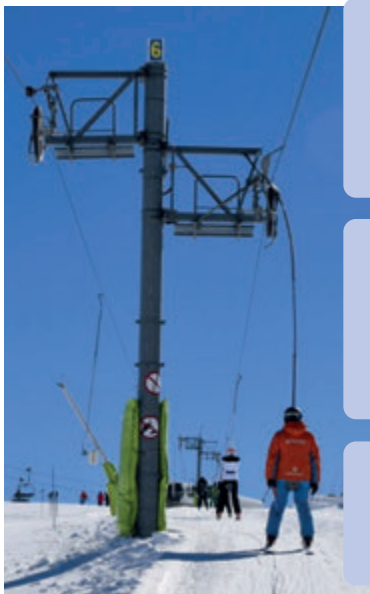

ANELLI DI SICUREZZA

IN GOMMA O POLIURETANO

ASSE CORTO DA 11,5 MM O ASSE LUNGO DA 12,5 MM



TUBO IN POLIETILENE SPACCATO E NON SPACCATO

DIAMETRI DA 21 MM A 61,4 MM - ROBUSTO DESIGN IN POLIETILENE

DIVERSE LUNGHEZZE: 2,42 M - 2,70 M - 3,58 M - 3,70 M - ROTOLO DA 50 M



ALTRI PEZZI SPECIFICI

COMPATIBILI AL 100% CON I PRODUTTORI

Pezzi compatibili con i marchi

GMM® - Poma® - Tatralift® - etc.

IMPIANTI A MORSA FISSA

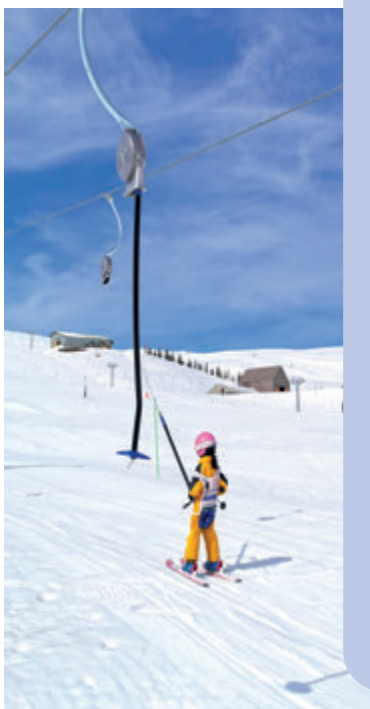

T-BAR COMPLETI PALI E SELLETTE

MODELLO PRESENTATO
06914 T-BAR + SELLETTA 1500MM



SOSPENSIONI

MODELLO PRESENTATO
07349 SOSPENSIONE TIPO O



TRAINI E MOLLE

MODELLO PRESENTATO
07333 TRAINO DI SCIOVIE TIPO 200



MODELLO PRESENTATO
01150 MOLLA PER TRAINO



FORCELLE DI ROTTURA E SUPPORTI

MODELLO PRESENTATO
00243 FORCELLA DI ROTTURA 140

MODÈLE PRÉSENTÉ
07213 SUPPORTO FORCELLA DI ROTTURA



MORSE E ADATTATORI

MODELLO PRESENTATO
07343 MORSA TAGLIA L (TIPO BC)



MODELLO PRESENTATO
07003 TESTA IN GOMMA T-BAR M16

E ALTRO SU

SHOP.IDM-FRANCE.COM

Pezzi compatibili con i marchi

Axet® - Doppelmayr® - Garaventa® - Leitner® - LST® - Poma® - Städeli® - etc.



RICAMBI PER CINGOLATURE

Ottimizzate le prestazioni dei vostri gatti delle nevi con la nostra selezione di pezzi di ricambio per cingolature! Qualità, compatibilità e durata garantite grazie alla nostra partnership con Hans Hall. IDM, il vostro esperto per un battipista senza compromessi. Guidate in tutta sicurezza, in qualsiasi condizione.

COMPATIBILITÀ GARANTITA AL 100%

+ DI 300 RIFERIMENTI PROPOSTI

CINGOLATURE LAVORATE IN AZIENDA

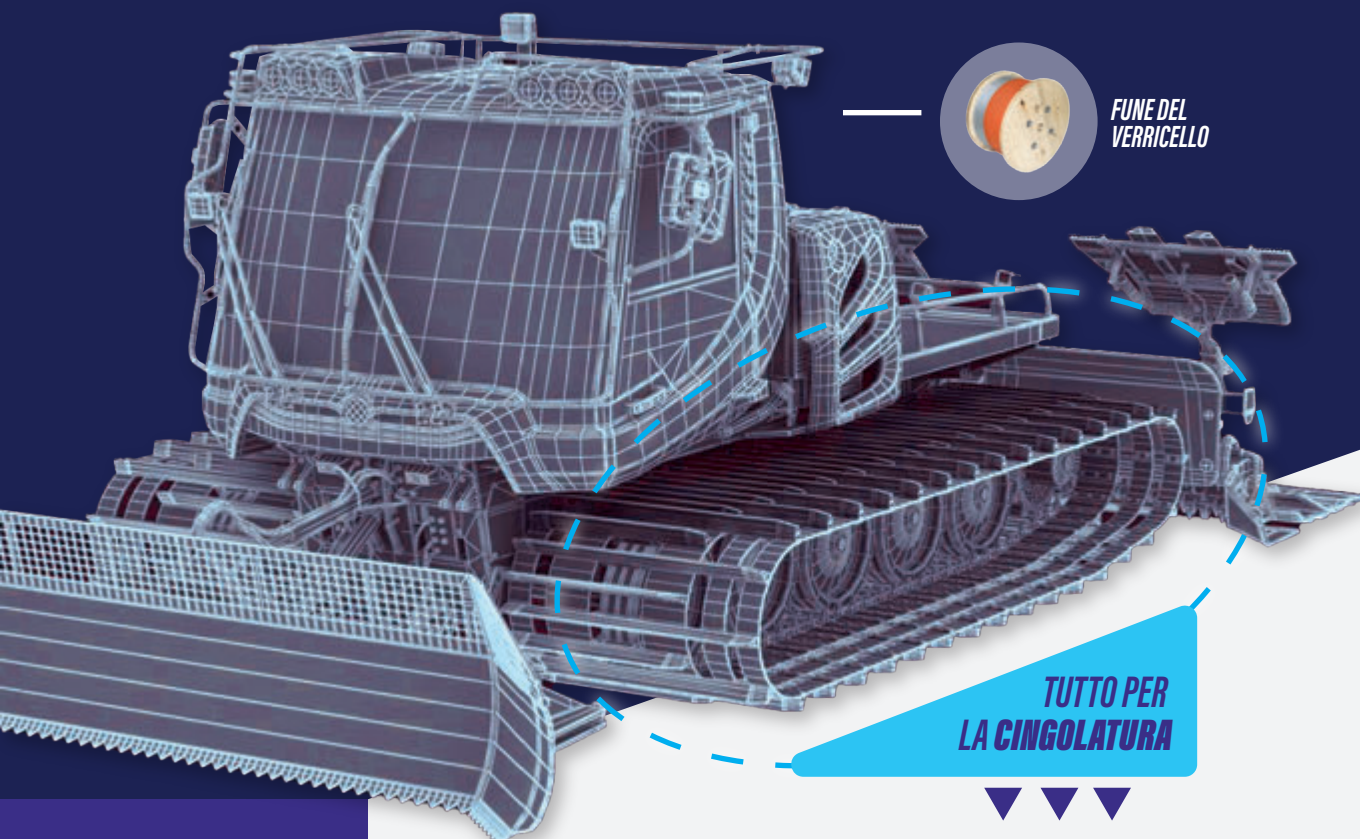

FUNE DEL VERRICELLO

TUTTO PER LA CINGOLATURA

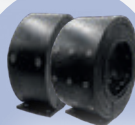

NASTRI IN GOMMA

AMMISSIBILI AL RICICLAGGIO ECOVERTIS



TRAVERSE

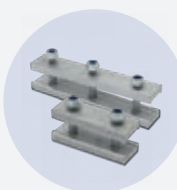

CERNIERE



RUOTE PIENE



PIASTRINE



GUIDA RUOTE



GUIDA CATENE

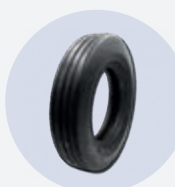

GOMME E TUBI



VITERIA

L'ALTERNATIVA ECOLOGICA

SRI / EV BELT



SEMPERIT
Since 1900.

Nastro in gomma con 23% di materiale riciclato e di origine biologica



CINGOLATURE COMPLETE SU MISURA

MONTATO DAL
NOSTRO TEAM
IN SAVOIA (FRA)



CINGOLATURA COMPLETA
IDM



- ▶ CINGOLATURA PRONTA PER IL MONTAGGIO
- ▶ LUNGA DURATA E MANUTENZIONE RIDOTTA
- ▶ PERSONALIZZABILE SECONDO LE VOSTRE ESIGENZE

OLTRE 3.000 ORE
DI FUNZIONAMENTO

1 Scegliete la **configurazione** e il **tipo di gomma**



5 NASTRI



6 NASTRI



7 NASTRI

AUTORESSURIDEMANDE



NASTRI CLASSICI
GOMMA AD ALTA DENSITÀ



NASTRI SRI EV BELT
23% DI MATERIALE RICICLATO

2 Il **tipo** di cingolatura



INVERNO
PERFORMANTE E ROBUSTO



4 STAGIONI
EFFICACE E POLIVALENTE

+ ACCESSORI SU RICHIESTA (PICC. A GHIACCIO, ANTIRIBALTAMENTO...)





RICAMBI PER FRESA

HAI DOMANDE?

+33 479 84 34 34
shop.idm-france.com

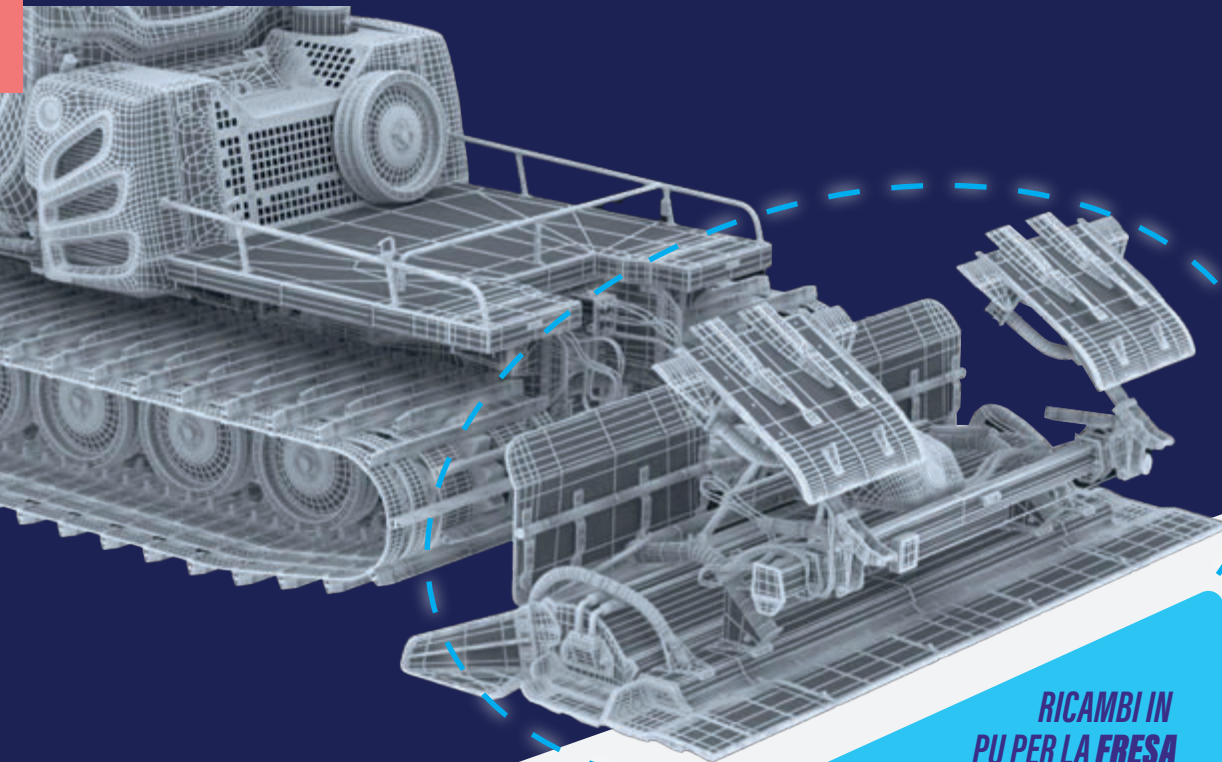

**RICAMBI IN
PU PER LA FRESA**

PER LA GARAGE
ABBIATE IL RIFLESSO

ZIGZAG



PROTEGGI PAVIMENTO E TRAVERSE

RIVESTIMENTO RIVALUTATO

ALTISSIMA RESISTENZA

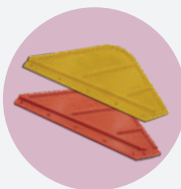

● **BAVETTE - LISCIATORI -
SUPPORTI PER BAVETTE...**

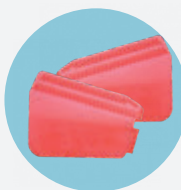

● **FLAP ADATTABILI -
FLAP LATERALI...**



● **COPERTURE - FRANGE -
DEVIATORI...**

LE NOSTRE CINGOLATURE E I NOSTRI RICAMBI PER BATTIPISTA SONO COMPATIBILI CON I MARCHI

Prinoth® - Leitner® - Kassbohrer Pistenbully® - Bombardier® - Per altri produttori, contattateci!

TUBI - RACCORDI - ACCESSORI E SERVIZI

REALIZZAZIONE SU MISURA

+ DI 50.000 TUBI VENDUTI

TUBI ASSEMBLATI IN AZIENDA



CREA IL TUO TUBO SEMIRIGIDO IDM

1 Scegli la lunghezza totale



2 Il diametro interno

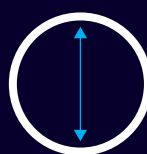

IN POLLICE

1/2	1
3/4	1.5
5/8	2

3 I raccordi - adattatori o accoppiatori



TIPO A



TIPO B



TIPO C



TIPO D



TIPO DC



TIPO DP



TIPO E



TIPO F

▶ MANICHETTE PIATTE



Con adattatore e giunto GROWAG
Lunghezza standard: 20 m
Altre lunghezze su richiesta

▶ RIPARAZIONE DI TUBI



Ripariamo i vostri tubi
Per tutti i diametri
Per tutte le lunghezze

▶ COPERTURA CUBICA PER GENERATORE



Equipaggia il tuo generatore di neve con la copertura cubica IDM. Facile da installare, protegge il tuo dispositivo dalle condizioni estive

▶ RIPARAZIONE DI CORPI DI VALVOLE



Un corpo valvola al limite? Ridategli vita! IDM si occupa della riparazione e del retrofit delle vostre valvole.

I NOSTRI RICAMBI PER LA NEVE SONO COMPATIBILI CON TUTTI I MARCHI

Demacenko® - Sufag® - Technoalpin® - etc.



RIVESTIMENTI PER PAVIMENTI ANTISCIVOLO

Esplora la vasta gamma di rivestimenti antiscivolo IDM, progettati per combinare sicurezza e durata. Disponibili in diversi materiali, spessori e finiture, i nostri rivestimenti si adattano a tutte le vostre esigenze: zone ad alto traffico, conformità alle norme per disabili, classificazione antincendio e altro ancora. Realizzati con precisione, garantiscono aderenza e resistenza anche in condizioni estreme.

PROGETTATI PER LA MONTAGNA

+ DI 100 RIVESTIMENTI DISPONIBILI

AMMISSIBILI AL RICICLAGGIO ECOVERTIS

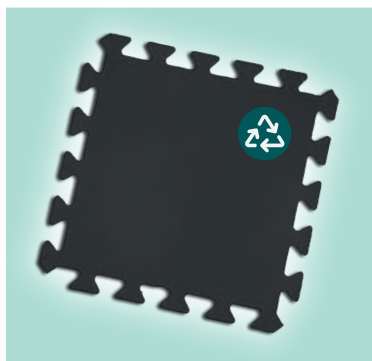

LASTRA RICICLATA ECOVERCLIP

PROGETTATO CON IL 75% DI PEZZI DI RICAMBIO USATI RACCOLTI NELLE STAZIONI SCIISTICHE PARTNER

- Lastra antiscivolo performante
- Lastra certificata antifuoco CFL-S1
- Durevole, resistente alle intemperie
- Facile da posare grazie al sistema di clip

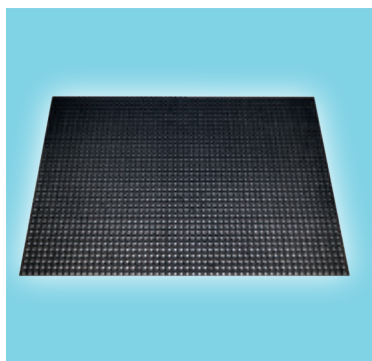

RIVESTIMENTO PRM M25

LA SOLUZIONE IDEALE PER IL TRAFFICO INTENSO CON COMPATIBILITÀ PMR

- Composto al 100% da gomma naturale
- Ultra antiscivolo grazie alle sottili sporgenze
- Drenante e resistente alle condizioni estreme
- Tappeto certificato antifuoco CFL-S1

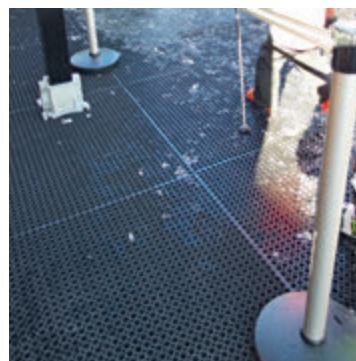

RIVESTIMENTO IN ROTOLO M69 MINI

EFFICIENZA, PRESTAZIONI E SEMPLICITÀ IN UN UNICO GRIGLIATO

- Composto da gomma naturale e riciclata
- Formato in rotolo facile da installare
- Maggiore drenaggio di acqua e neve

DISPONIBILE ANCHE IN TAPPETO



TUTTI I NOSTRI ALTRI RIVESTIMENTI ANTISCIVOLO SU

[SHOP.IDM-FRANCE.COM](https://shop.idm-france.com)

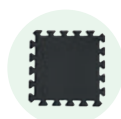

LASTRE ECOSOSTENIBILE



RIVESTIMENTI D'INTERNO



RIVESTIMENTI E ROTOLI FORATI

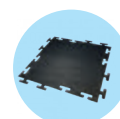

RIVESTIMENTI E ROTOLI PIENI

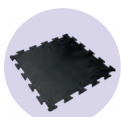

RIVESTIMENTI NORME ANTINCENDIO

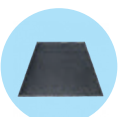

RIVESTIMENTI PER ESTERNI

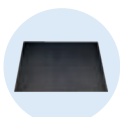

PAVIMENTI A NORMA PRM



COLLE E ACCESSORI



RIVESTIMENTI PER PAVIMENTI SCIVOLOSI



MIGLIORA IL TUO IMBARCO

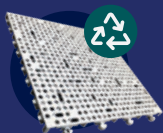

LASTRA CON CLIP LOADY

ROBUSTO | FACILE DA INSTALLARE | 28% RICICLATO



PROFILO A T

DEMARCAZIONE DEI CORRIDOI | 2 METRI



TARGA STOP

SEGNALETICA IN PE E ASTROSKI | 2-8 POSTI

ALTRI COLORI E MATERIALI SU RICHIESTA!

GLI ALTRI PAVIMENTI SCIVOLOSI ▼



ROTOLO MR. SNOW

LA MIGLIORE SENSAZIONE DI SCIATA
IDEALE PER LO SBARCO



ROTOLO ASTROSKI

ANTISCIVOLO PER I PEDONI
IDEALE PER L'IMBARCO



ROTOLO SKI GLISS

L'EFFICIENZA A UN PREZZO CONTENUTO
IDEALE PER LO SBARCO



E ALTRO SU

SHOP.IDM-FRANCE.COM

**OVUNQUE VI TROVIATE
ACCEDETE A OLTRE 1500 REFERENZE SU**

SHOP.IDM-FRANCE.COM



  **CATALOGO IDM**



IMPIANTI A FUNE - SCIOVIE - BATTIPISTA - INNEVAMENTO - PAVIMENTI

+33 4 79 84 34 34

shop.idm-france.com

Dal lunedì al venerdì dalle 8:00 alle 12:15
e dalle 13:30 alle 17:45 (ora francese)

Più di 2.000 riferimenti IDM accessibili
online 24 ore su 24, 7 giorni su 7